

ISOLI

KLUBB



SLIDE 4

CARRI SOCCORSO

VÉHICULES DE DÉPANNAGE

BREAKDOWN TRUCKS

ABSCHLEPPWAGEN

ISOLI@ISOLI.COM

WWW.ISOLI.COM

DIMENSIONI

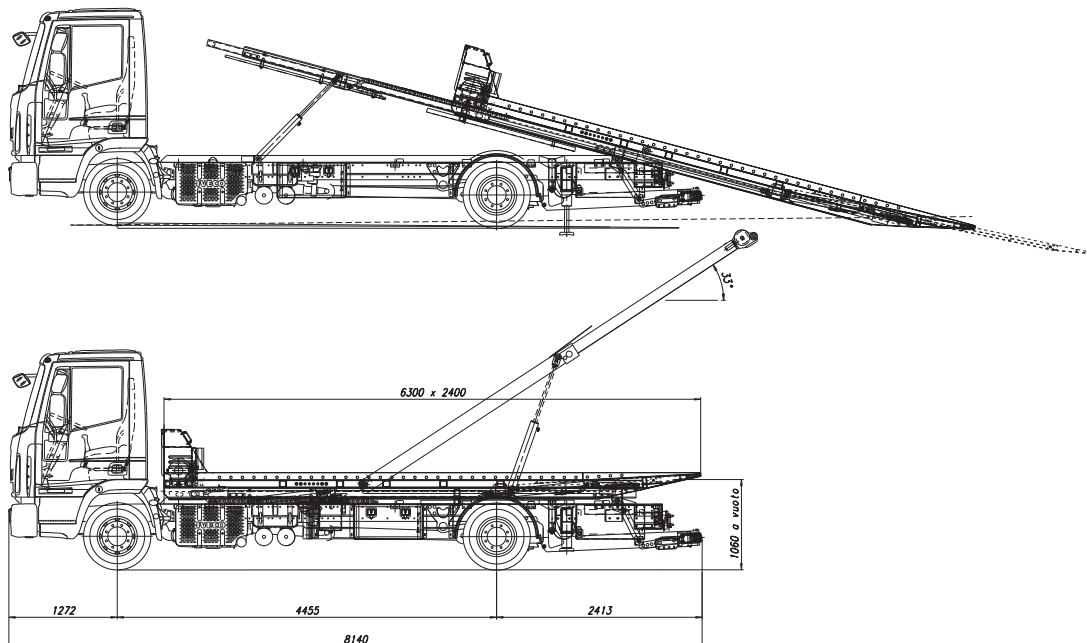

DIMENSIONS / OVERALL DIMENSION / GESAMTABMESSUNGEN [mm]

IVECO EUROCARGO ●

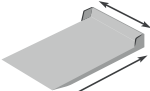
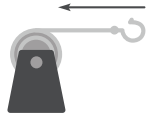
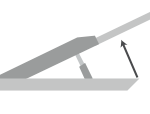
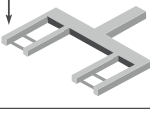
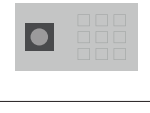

CARATTERISTICHE TECNICHE

CARACTÉRISTIQUES TECHNIQUES / TECHNICAL FEATURES / TECHNISCHE EIGENSCHAFTEN

	<p>Pianale <i>Plateau</i> <i>Flatbed</i> <i>Flachbett-Abmessungen</i></p>	<p>6.300 x 2.400 mm</p>
	<p>Tiro del verricello <i>Force de traction du treuil</i> <i>Winch pulling force</i> <i>Zugkraft der Winde</i></p>	<p>4.500 kg</p>
	<p>Portata del braccio sollevabile <i>Charge utile du bras de levage</i> <i>Lifting boom capacity</i> <i>Traglast der Hinterradgabel</i></p>	<p>4.000 kg</p>
	<p>Portata della forca <i>Charge utile de la fourche</i> <i>Fork capacity</i> <i>Traglast der Hinterradgabel</i></p>	<p>2.500 / 3.000 / 3.500kg</p>
	<p>Comandi <i>Commandes</i> <i>Controls</i> <i>Steuerungen</i></p>	<p>Remote control <i>Télécommande</i> <i>Fernbedienungen</i></p>
	<p>Stabilizzatori idraulici <i>Stabilisateurs hydrauliques</i> <i>Hydraulic stabilisers</i> <i>Hydraulische Stabilisatoren</i></p>	<p>2</p>